

Test Point with "DIN 2353" Compression Connection

Light Series / Heavy Series

Test Point Connection M16x2

160 - 630 BAR Rated



TEST POINTS

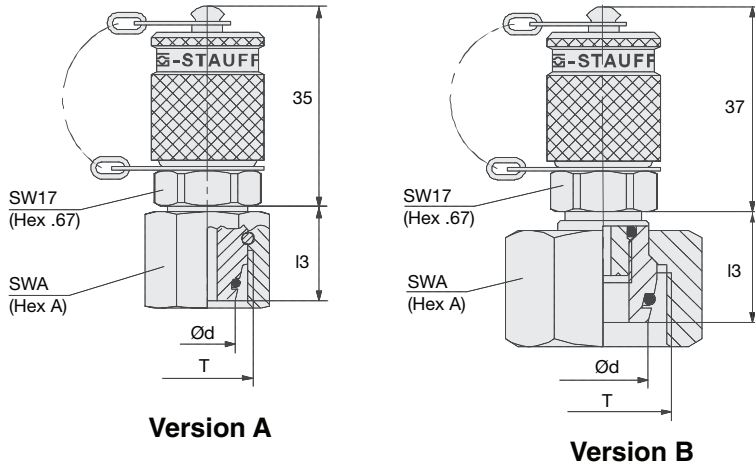

Materials

Body Steel
 316 Stainless Steel - On Request
 Seal NITRIL - Others On Request
 Temp. Range -30 to +100°C

Light Series

TUBE O.D.	T	l3	SW A	Version	PN BAR	Article no.	Price £	Price €
6	M12 x 1.5	15.5	14	A	315	20.51.06	£24.30	€29.10
8	M14 x 1.5	15.5	17	A	315	20.51.08	£18.20	€21.80
10	M16 x 1.5	16.5	19	A	315	20.51.10	£18.30	€22.00
12	M18 x 1.5	17.5	22	A	315	20.51.12	£19.20	€23.10
15	M22 x 1.5	21	27	B	315	20.51.15	£25.40	€30.50
18	M26 x 1.5	19.5	32	B	315	20.51.18	£28.70	€34.50
22	M30 x 2	20.5	36	B	160	20.51.22	£33.50	€40.30
28	M36 x 2	25	41	B	160	20.51.28	£43.30	€52.00
35	M45 x 2	30	50	B	160	20.51.35	£42.10	€50.60
42	M52 x 2	31	60	B	160	20.51.42	£43.20	€51.90

Heavy Series

TUBE O.D.	T	l3	SW A	Version	PN BAR	Article no.	Price £	Price €
6	M14 x 1.5	14.5	17	A	630	20.52.06	£24.30	€29.10
8	M16 x 1.5	16.5	19	A	630	20.52.08	£19.60	€23.50
10	M18 x 1.5	16.5	22	A	630	20.52.10	£27.00	€32.40
12	M20 x 1.5	17.5	24	A	630	20.52.12	£21.10	€25.30
14	M22 x 1.5	19.5	27	B	630	20.52.14	£26.60	€31.90
16	M24 x 1.5	18	30	B	400	20.52.16	£30.20	€36.30
20	M30 x 2	24	36	B	400	20.52.20	£37.60	€45.10
25	M36 x 2	26	46	B	400	20.52.25	£40.30	€48.30
30	M42 x 2	30	50	B	400	20.52.30	£42.80	€51.30
38	M52 x 2	34	60	B	315	20.52.38	£44.70	€53.60